

MAGNA™

INDUSTRIAL

Schrauberbits

Screwdriver Bits

Embouts de vissage



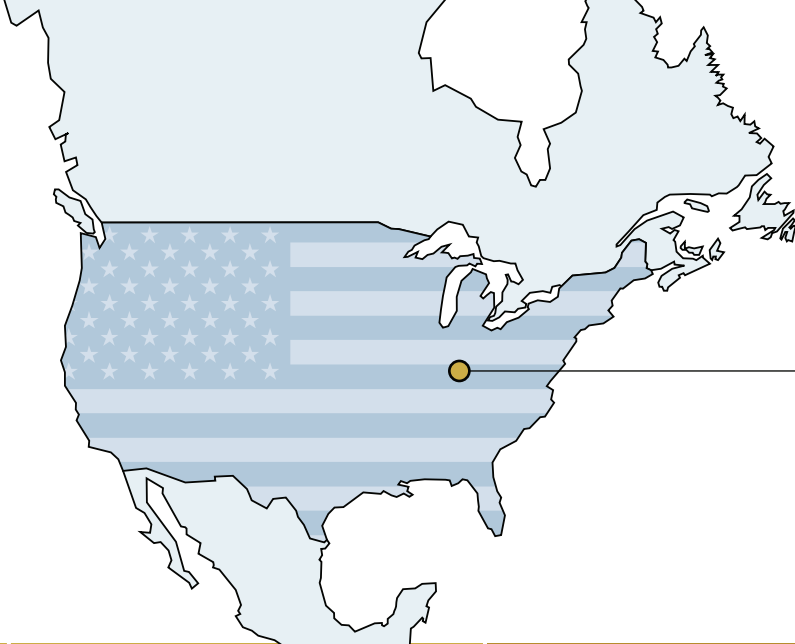

MAGNA™

**MAGNA – von Profis
für Profis.**

MAGNA, ein Unternehmen mit Sitz in Elizabethtown (Kentucky, USA) und einem europäischen Zentrallager in Ravensburg (Deutschland), ist Profis in aller Welt seit Jahrzehnten ein Begriff für Schrauberbits.

Als erfahrener Hersteller für anspruchsvolle Anwender in der industriellen Produktion investieren wir laufend in neue Technologien und passen unsere Produktpalette den Kundenbedürfnissen an, sodass wir Ihnen ein breites Bitsortiment für alle Schraubfälle anbieten können. Bits, die Leistung und Lebensdauer unter den Qualitätszeichen MAGNA und «Made in USA» vereinen.

**MAGNA – from professionals
for professionals.**

MAGNA, a company based in Elizabethtown (Kentucky, USA) and with a central European warehouse in Ravensburg (Germany), has been a familiar name to professionals worldwide for decades in the field of screwdriver bits.

As an experienced manufacturer for demanding users in industrial production, we continually invest in new technologies and adapt our product range to suit customer requirements so that we can offer you a wide range of bits for all screwing applications. Bits which combine excellent performance and service life under the MAGNA and «Made in USA» marks of quality.

**MAGNA – par les professionnels
pour les professionnels.**

MAGNA est une entreprise dont le siège se trouve à Elizabethtown (Kentucky, USA). Elle dispose d'un entrepôt central européen à Ravensburg (Allemagne) et est connue depuis des décennies par les professionnels du monde entier pour ses embouts de vissage.

En tant que fabricant expérimenté pour les utilisateurs exigeants dans le secteur de la production industrielle, nous investissons constamment dans de nouvelles technologies et adaptons notre palette de produits aux besoins de nos clients. Ceci nous permet de vous proposer un vaste assortiment d'embouts convenant pour tous les cas de vissage. Des embouts conciliant puissance et durée de vie sous les marques de qualité MAGNA et «Made in USA».





MAGNA – Qualität zuerst.



MAGNA – quality first.



MAGNA – la qualité d'abord.

In unserer Forschungsabteilung entwickeln wir innovative Lösungen wie das patentierte MAGNA-Härteverfahren ISO-TEMP® und den revolutionären MAXgrip-Bit. Zudem stellen wir die Qualität sicher – von der Rohstoffprüfung bis zur Endkontrolle.

Mit unseren optimalen Produktionsverfahren für alle Bitarten können wir Anwenderwünsche erfüllen und höchste Qualität bieten.

Als Anwender treffen Sie aus dem MAGNA-Programm immer die richtige Wahl: für jeden marktüblichen Schraubentyp den passenden Schrauberbit im benötigten Härtegrad und mit der geeigneten Antriebsform.

In our research we develop innovative solutions such as the patented MAGNA tempering process ISO-TEMP® and the revolutionary MAXgrip. In addition, we assure quality – from the control of raw materials right through to the final inspection.

With our optimum production processes for all bit types, we are able to meet user requirements and offer first-class quality.

As the user, you always make the right choice from the MAGNA range: the right screwdriver bit for every conventional type of screw in the required tempering quality and with the appropriate drive dimension.

Dans le cadre de nos recherches, nous développons des solutions novatrices comme le procédé de dureté breveté MAGNA ISO-TEMP® et l'embout révolutionnaire MAXgrip. En plus, nous assurons la qualité – depuis le contrôle des matières premières jusqu'au contrôle final.

Grâce à notre procédé optimal de production de tous types d'embouts, nous sommes à même de réaliser tous les souhaits des utilisateurs et de garantir en permanence une qualité de première classe.

En tant qu'utilisateur, vous ferez toujours le bon choix à partir du programme MAGNA: pour chaque type de tournevis disponible sur le marché, l'embout de tournevis qui convient dans la qualité de dureté requise et avec la forme d'entraînement appropriée.

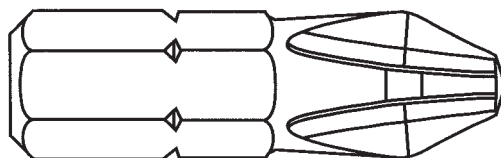
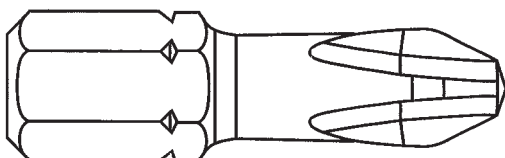

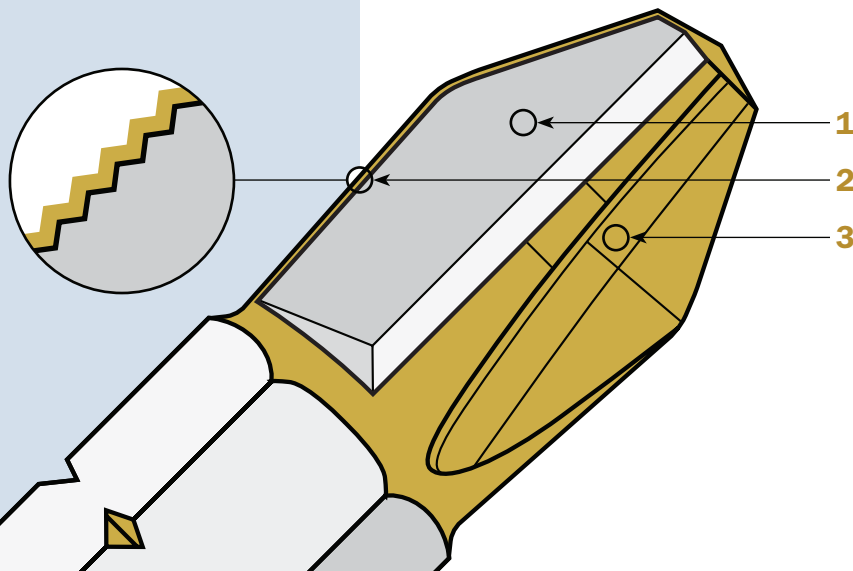

Innovation durch Kombination.

Mit dem MAXgrip-Bit bringt MAGNA einen innovativen Bit auf den Markt, der für den Universaleinsatz bahnbrechend ist. Er besteht aus einem besonders hochwertig gehärteten Werkzeugstahl **(1)**, der mit spezieller Mikrosplit-Bestrahlung aufgeraut **(2)** und für eine lange Lebensdauer mit Titaniumnitrid (TiN) beschichtet ist **(3)**.

Diese Beschichtung verhindert eine Verflachung der aufgerauten Oberfläche und reduziert gleichzeitig den Verschleiß.

Das Ergebnis dieses Prozesses ist ein besonders langlebiger, haftstarker Bit, der sich in den Schraubenkopf «verbeißt», ohne ihn dabei zu beschädigen.

Innovation through combination.

With the MAXgrip, MAGNA is launching a revolutionary new bit on the market for universal use. It is made of a particularly high-quality tempered tool steel **(1)**, which is roughened with special micro-split blasting **(2)** and coated with titanium nitride (TiN) for a long service life **(3)**.

This coating prevents a smoothing out of the roughened surface and at the same time reduces wear.

The result of this process is a particularly durable, highly adhesive bit which becomes fixed in the screw head without damaging it.

L'innovation par la combinaison.

Avec MAXgrip, MAGNA introduit sur le marché un embout novateur, révolutionnaire pour l'utilisation universelle. Il se compose d'un acier à outils trempé de qualité supérieure **(1)**, rendu rugueux par décapage spécial aux microfragments **(2)** et revêtu de nitrure de titanium (TiN) pour garantir une longue durée de vie **(3)**.

Ce revêtement empêche une égalisation de la surface décapée et diminue en même temps l'usure.

Ce procédé a pour résultat un embout d'une durée de vie particulièrement longue et fortement adhésif, qui se grippe dans la tête de vis sans pour cela l'endommager.

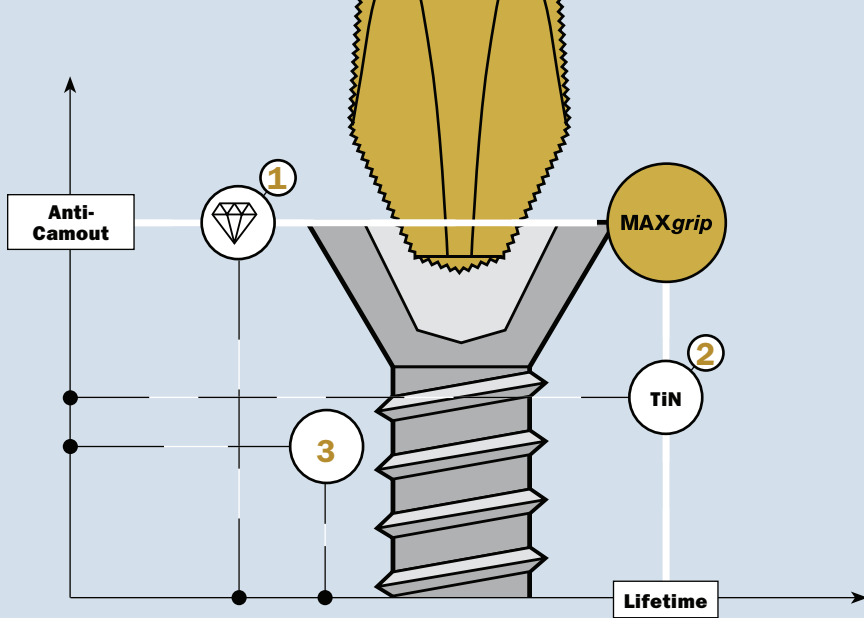

Anti-Camout-Verhalten und hohe Lebensdauer.

Anti-Camout behaviour and long service life.

Comportement «Anti-Camout» et longue durée de vie.

Der MAXgrip-Bit ist eine wegweisende Neuentwicklung, die erstmals hervorragendes Anti-Camout-Verhalten mit langer Lebensdauer kombiniert. Auf Grund der mikrorauen Oberfläche verkrallt er sich in der Schraube und weist daher ein hervorragendes Anti-Camout-Verhalten auf. Wegen der verschleißfesten TiN-Beschichtung haben MAXgrip-Bits außerdem eine sehr lange Lebensdauer.

Zudem verfügt der MAXgrip-Bit über eine optimierte Geometrie für maximale Passform im Schraubenkopf und eine Torsionszone gegen Bruch bei Drehmomentspitzen.

Die innovativen MAXgrip-Bits verbinden also die Vorteile exzellenten Anti-Camout-Verhaltens und einer hohen Lebensdauer und setzen neue Maßstäbe für universelle Anwendungen.

Zum Vergleich: Anti-Camout und Lebensdauer bei diamantpartikelbesetzten Bits **(1)**, TiN-Bits **(2)** und herkömmlichen Bits **(3)**.

The MAXgrip bit is a groundbreaking new development that combines outstanding Anti-Camout behaviour with a long service life for the first time. Thanks to the microrough surface it clutches the screw and therefore has excellent Anti-Camout behaviour. Due to the wear-resistant TiN coating, MAXgrip bits also have a very long service life.

In addition, the MAXgrip bit has an optimized geometry for a perfect fit in the screw head and a torsion zone against breakage during torque peaks.

The innovative MAXgrip bits thus combine the advantages of excellent Anti-Camout behaviour with a long service life and set new standards for universal application.

By comparison: Anti-Camout and service life of diamond-particle-tipped bits **(1)**, TiN bits **(2)** and conventional bits **(3)**.

L'embout MAXgrip est une innovation porteuse d'avenir, qui combine pour la première fois comportement «Anti-Camout» et longue durée de vie. Grâce à sa surface à rugosité microscopique, il se grippe dans la vis et a dès lors un excellent comportement «Anti-Camout». A cause du revêtement TiN résistant à l'usure, les embouts MAXgrip ont en plus une longue durée de vie.

En outre, l'embout MAXgrip dispose d'une géométrie optimisée s'adaptant parfaitement dans la tête de vis et d'une zone de torsion empêchant la rupture en cas de couples de pointe.

Les embouts MAXgrip innovants concilient donc les avantages de l'excellent comportement «Anti-Camout» et une longue durée de vie et établissent de nouveaux critères de qualité pour les applications universelles.

Comparaison: «Anti-Camout» et durée de vie des embouts garnis de particules diamantées **(1)**, des embouts TiN **(2)** et des embouts traditionnels **(3)**.

1

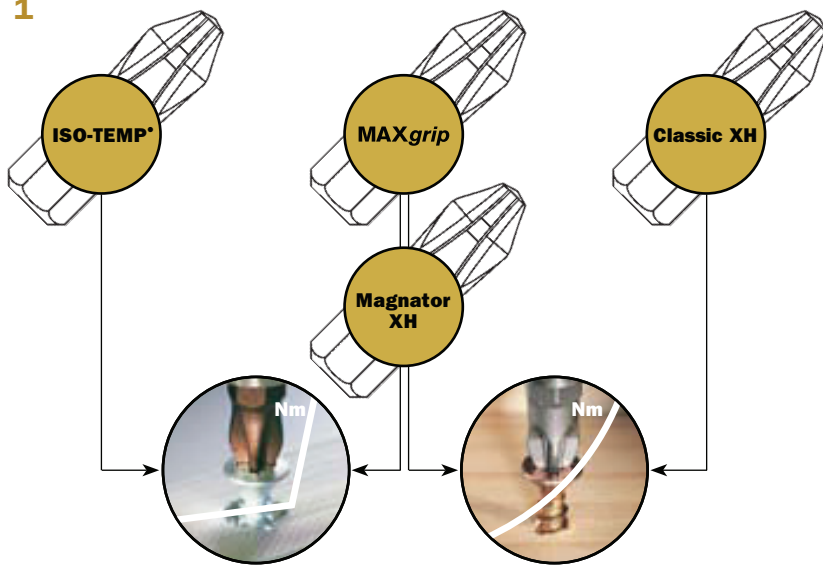

Vier Arten für alle Anwendungen.

Four types for all applications.

2

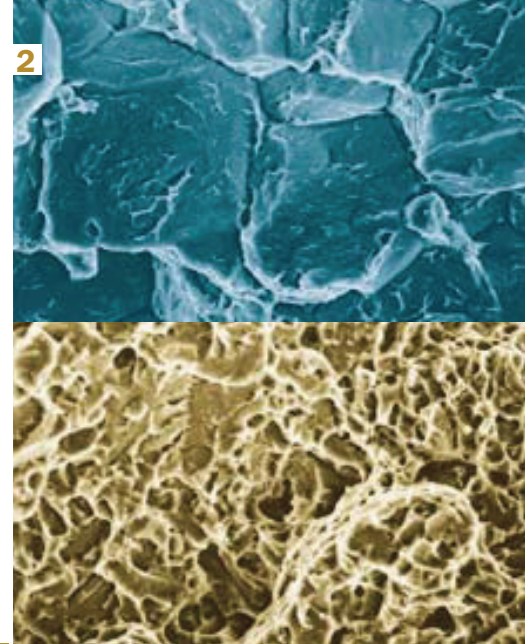

Quatre types pour toutes les applications.

1) Der **ISO-TEMP®**-Bit ist optimal für «harte» Schraubfälle, bei denen vor allem Haarrissbildung und Ermüdungsbrüche zu Ausfällen führen. Das von MAGNA entwickelte und patentierte Härteverfahren ISO-TEMP® sorgt dank hoher Bruch- und Abriebfestigkeit für eine lange Lebensdauer des Bits.

Die «Generalisten» unter den Bits heißen **MAXgrip** und **Magnator XH**. Ihre Extrahärte und optimierte Torsionsgeometrie machen sie universell einsetzbar.

Der **Classic XH**-Bit eignet sich besonders für «weiche» Schraubfälle, bei denen Abrieb und Bruch durch Drehmomentbelastung die Standzeit der Bits begrenzen.

2) Mikroskopischer Vergleich: Gefügestruktur beim Classic XH-Bit (oben), speziell verdichtete Struktur beim ISO-TEMP® -Bit (unten).

1) The **ISO-TEMP®** bit is ideal for «hard» screwing applications where particularly hairline fractures and breakages due to material fatigue lead to failures. Thanks to its high resistance to breakage and abrasion, the ISO-TEMP® tempering process developed and patented by MAGNA ensures long service life of the bit.

The «generalists» among the bits are called **MAXgrip** and **Magnator XH**. Their extra hardness and optimized torsion geometry make them ideal for universal use.

The **Classic XH** bit is particularly suitable for «soft» screwing applications where abrasion and breakage due to torque load reduce the service life of the bits.

2) Microscopic comparison: Structure of the Classic XH bit (above), specially consolidated structure of the ISOTEMP® bit (below).

1) L'embout **ISO-TEMP®** convient parfaitement pour les cas de vissage «durs», où ce sont les fissurations et les ruptures de fatigue qui entraînent des pannes. Le procédé de dureté breveté et développé par MAGNA ISO-TEMP® assure une longue durée de vie de l'embout grâce à une forte résistance à la rupture et à l'abrasion.

Les «généralistes» parmi les embouts se nomment **MAXgrip** et **Magnator XH**. Leur extrême dureté et leur géométrie de torsion optimisée en permettent une utilisation universelle.

L'embout **XH Classic** convient particulièrement pour les cas de vissage «doux», où abrasion et rupture limitent la durée de vie des embouts en raison de la charge du couple.

2) Comparaison microscopique: structure cristalline pour l'embout XH Classic (ci-dessus), structure spécialement comprimée pour l'embout ISOTEMP® (ci-dessous).





**Das MAGNA
Schrauberbit-Programm.**

**The MAGNA screwdriver
bit range.**

**Le programme d'embouts
de vissage MAGNA.**

	Bits und Klingen	Screwdriver bits	Embouts de vissage	
	Pozidriv®	Pozidriv®	Pozidriv®	10 – 11
	Phillips®	Phillips®	Phillips®	12 – 14
	Torx®	Torx®	Torx®	15 – 16
	Torxalign®	Torxalign®	Torxalign®	17
	Torx® Tamper Resistant	Torx® Tamper Resistant	Torx® Tamper Resistant	17
	Schlitz	Slotted	Tête fendue	18 – 19
	Sechskant	Hex	Six pans creux	20
	Vierkant	Square	Carée conique	21
	Torq-Set®	Torq-Set®	Torq-Set®	22
	Tri-Wing®	Tri-Wing®	Tri-Wing®	23
	Spanner	Spanner	Spanner	23
	Doppelbits	Double-ended bits	Embouts de vissage doubles	24
	Set	Set	Assortiment	25 – 28
	Bithalter	Bit holder	Porte-embouts	29 – 30
	Steckschlüsseleinsätze	Nutsetters	Douilles directes	31
	Steckschlüssel	Sockets	Douilles	32
	Verlängerungen	Extensions	Rallonges	32
	Adapter Vierkant-Hex	Adapter square-hex	Adaptateur hex. à tête carrée	33
	Schraubenzieher	Screwdriver	Tournevis	33
	Profilmäßtabellen	Profile measurement tables	Tables des mesures de profil	35

	Gerippt	Ribbed	Profil nervuré
	Magnetisch	Magnetic	Magnétique
	Nicht magnetisch	Nonmagnetic	Non magnétique
	Kugelsicherung	Ball lock	Bille d'arrêt
	Stiftsicherung	Pin lock	Goupille d'arrêt
	C-Ring	C-ring	Bague en C
	O-Ring	O-ring	Bague en O
	Bestelleinheit	Order unit	Unité de commande

Torx® and Torxalign® are registered trademarks of Camcar Div., Textron Inc.

Phillips®, Torq-Set® and Tri-Wing® are registered trademarks of Phillips® Screw Co.











ISO-TEMP® is a registered trademark of Magna Industrial Tools.

Pozidriv® is a registered trademark of European Industrial Services Limited.

Die unten stehende Tabelle informiert schnell und einfach, wo Sie Ihren Schraubendreherbit im Katalog finden können. Wählen Sie gewünschte Antriebsart und Schraubenkopf aus: Das passende Feld enthält die Seitenzahl.

The table below provides at-a-glance information on where to find your screwdriver bit in the catalogue. Select the required type of drive and screw head: the relevant box contains the page number.

Le tableau ci-dessous vous servira de guide pour trouver rapidement votre embout de tournevis dans le catalogue. Choisissez le type d'entraînement et tête de vis souhaités: la case correspondante indique le numéro de page.

	1/4" DIN 3126 C 6.3	5/16" DIN 3126 C 8	1/4" DIN 3126 E 6.3	7/16" DIN 3126 E 11.2	M5	10/32" NF2A
 PZ	10	10	11		11	12
 PH	12	13	13/14		14	14
 T	15	15	15/16			
 TW	17		17			
 TH	17					
 LS	18	18	19			
 SW	20	20	20			
 R	21		21			
 TQ	22	22	22	22		
 TW	23		23			
 SP	23					



1/4" DIN 3126 C6.3

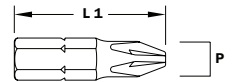

P	L1 mm		Iso-Temp®	MAXgrip+	Magnator XH+	Classic XH
Pz0	25	10				221684
Pz1	25	10	217176	221692	221685	216571
Pz1	25	100	221697		221686	
Pz1	25	100				224641
Pz2	25	10	217177	221693	221687	216573
Pz2	25	100	221699	221694	221688	224642
Pz3	25	10	217216	221695	221689	216575
Pz3	25	100	221701		221690	224643
Pz4	25	5				221691



P	L1 mm		Iso-Temp®	Classic XH
Pz1	51	10		221702
Pz2	51	10	222407	221703
Pz3	51	10		221704



P	L1 mm		Iso-Temp®	Classic XH
Pz1	25	10	217237	216765
Pz2	25	10	217238	216766
Pz2	25	100	221706	221705
Pz3	25	10	217239	216767



P	L1 mm		Iso-Temp®	Classic XH
Pz1R	25	10		224644
Pz2R	25	10	221709	221707
Pz2R	25	100	221710	221708

5/16" DIN 3126 C8

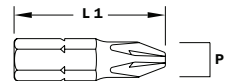

P	L1 mm		Iso-Temp®	Classic XH
Pz1	32	5		221711♦
Pz2	32	5		221712
Pz3	32	5	265019	221713
Pz4	32	5		221714

♦ Solange vorrätig / Available while stock lasts / Disponible jusqu'à épuisement des stocks

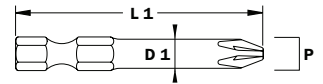
1/4" DIN 3126 E6.3

P	L1 mm	D1 mm		Iso-Temp®	MAXgrip	Classic XH
Pz1	49	4,8	5	217217	221720	216617
Pz2	49	6,3	5	217218	221721	216618
Pz2	49	6,3	100			221719
Pz3	49	6,3	5	217219	221722	216619

1/4" DIN 3126 E6.3

P	L1 mm		Iso-Temp®	Classic XH
Pz1	49	5	221726* (221723)	221723
Pz2	49	5	221727	221724
Pz3	49	5	221728** (221725)	221725



P	L1 mm		Impact
Pz2	49	5	265012



P	L1 mm	D1 mm		Iso-Temp®	Classic XH
Pz1	70	4,8	5	221735	221731
Pz2	70	6,3	5	221737	221732
Pz2	70	6,3	100		221733
Pz3	70	6,3	5	221736	221734



P	L1 mm	D1 mm		Iso-Temp®	Classic XH
Pz1	89	4,8	5	221741	221738
Pz2	89	6,3	5	221742	221739
Pz3	89	6,3	5	221743	221740

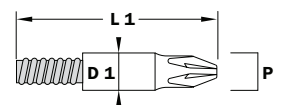

P	L1 mm	D1 mm		Iso-Temp®	Classic XH
Pz1	152	4,8	5	265015	221747
Pz2	152	6,3	5	221751	221748
Pz3	152	6,3	5		221749

M5 Gewinde / threaded / fileté

P	L1 mm	D1 mm		MAXgrip	Classic XH
Pz1	44,5	6,3	5	221753	
Pz2	44,5	6,3	5	221754	
Pz3	45	6,3	5		221755*

* Solange vorrätig (Empfehlung für Ersatzartikel) / Available while stock lasts (proposal for substitute) / Disponible jusqu'à épuisement des stocks (proposition de remplacement)

** Nicht mehr lieferbar (Empfehlung für Ersatzartikel) / No longer available on stock (proposal for substitute) / Indisponible en stock (proposition de remplacement)



10/32" Gewinde / threaded / fileté



P	L1 mm	D1 mm		MAXgrip
Pz2	44.5	6.3	5	221756 [♦]

1/4" DIN 3126 C6.3

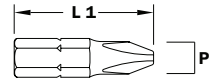

P	L1 mm		Iso-Temp [®]	MAXgrip ⁺	Magnator XH ⁺	Classic XH
Ph0	25	10				221759
Ph0	25	100				221760
Ph1	25	10	217190	221768	221761	216559
Ph1	25	100			221762	224645
Ph2	25	10	217191	221769	221763	216561
Ph2	25	100	221774	221770	221764	265016
Ph2	25	100				224646
Ph3	25	10	217192	221771	221765	216563
Ph3	25	100			221766	224647
Ph4	25	5				221767



P	L1 mm		Classic XH
Ph1	51	10	221776
Ph2	38	10	221777
Ph2	51	10	221778
Ph2	64	10	221779
Ph3	51	10	221780



P	L1 mm		Iso-Temp [®]	Classic XH
Ph1	25	10	221785	217255
Ph2	25	10	221786	217257
Ph2	25	100		221783
Ph3	25	10	221787	221784



P	L1 mm		Iso-Temp [®]	Classic XH
Ph1R	25	10		221788
Ph1R	25	100		221789
Ph2R	25	10	221793	221790
Ph2R	25	100		221791



P	L1 mm		Classic XH
Ph1R	51	5	221794
Ph2R	51	5	221795
Ph2R	76	5	221796

[♦] Solange vorrätig (Empfehlung für Ersatzartikel) / Available while stock lasts (proposal for substitute) / Disponible jusqu'à épuisement des stocks (proposition de remplacement)

5/16" DIN 3126 C8

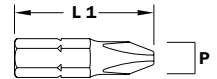

P	L1 mm		Iso-Temp®	Classic XH
Ph1	32	5		221797
Ph2	32	5	265020	221798
Ph3	32	5		221799
Ph4	32	5		221800



P	L1 mm		Classic XH
Ph2	32	10	221805

1/4" DIN 3126 E6.3

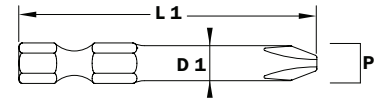

P	L1 mm	D1 mm		Iso-Temp®	MAXgrip	Classic XH
Ph0	49	4,8	5			217123
Ph1	49	4,8	5	216804	221810	216608
Ph2	49	6,3	5	217290	221811	216609
Ph2	49	6,3	100	221813		221809
Ph3	49	6,3	5	216805	221812	216610



P	L1 mm	D1 mm		Iso-Temp®	Classic XH
Ph1	49	4,8	5	221817* (216804)	221814
Ph2	49	6,3	5	221818	221815
Ph3	49	6,3	5	221819	221816



P	L1 mm	D1 mm		Iso-Temp®	Classic XH
Ph1	49	4,8	5	221823	221820
Ph2	49	6,3	5	221824	221821
Ph3	49	6,3	5	221825	221822



P	L1 mm	D1 mm		Iso-Temp®	Classic XH
Ph1	70	4,8	5		221826
Ph2	70	6,3	5	221831	221827
Ph2	70	6,3	100		221828
Ph3	70	6,3	5		221829

* Solange vorrätig (Empfehlung für Ersatzartikel) / Available while stock lasts (proposal for substitute) / Disponible jusqu'à épuisement des stocks (proposition de remplacement)



1/4" DIN 3126 E6.3

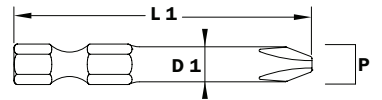

P	L1 mm	D1 mm		Iso-Temp®	Classic XH
Ph1	89	4,8	5	221834	222394
Ph2	89	6,3	5	221835	222395
Ph2	89	6,3	100		222396
Ph3	89	6,3	5	221836	221833



P	L1 mm	D1 mm		Classic XH
Ph1	102	4,8	5	221837
Ph2	102	6,3	5	221838
Ph2	102	6,3	100	221839
Ph3	102	6,3	5	221840



P	L1 mm	D1 mm		Iso-Temp®	Classic XH
Ph1	152	4,8	5		221844
Ph2	152	6,3	5	221848	221845
Ph3	152	6,3	5		221846

M5 Gewinde / threaded / fileté

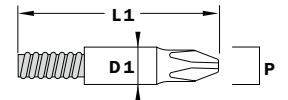

P	L1 mm	D1 mm		Classic XH
Ph2	44,5	6,3	5	221853

10/32" Gewinde / threaded / fileté NF2A

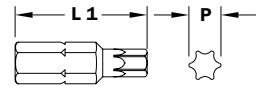

P	L1 mm	D1 mm		Classic XH
Ph2	45	6,3	5	221855

1/4" DIN 3126 C6.3

P	L1 mm		Iso-Temp®	MAXgrip	Classic XH
T6	25	5			221857
T7	25	5			221858
T8	25	5		221872	221859
T9	25	5			221860
T10	25	10	216845	221873	216984
T10	25	100			221861
T15	25	10	216846	221874	216985
T15	25	100			221862
T20	25	10	216847	221875	216986
T20	25	100			221863
T25	25	10	216848	221876	216987
T25	25	100			221864
T27	25	10	216849	221877	216988
T27	25	100			221865
T30	25	10	216850	221878	216989
T30	25	100			221866
T40	25	10	216851	221879	216990
T40	25	100			221867

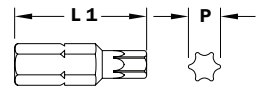
5/16" DIN 3126 C8

P	L1 mm		Classic XH
T30	32	5	221891
T40	32	5	221892
T45	32	5	221893
T50	32	5	221895
T55	32	5	221896

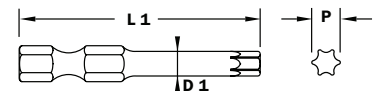
1/4" DIN 3126 E6.3



P	L1 mm	D1 mm		Iso-Temp®	Classic XH
T6	49	4,0	5		222055
T7	49	4,0	5		221920
T8	49	4,0	5		221921
T9	49	4,0	5		221922
T10	49	4,0	5	217208* (217017)	217017
T15	49	4,0	5	217209	217018
T20	49	4,7	5	217210	217019
T25	49	4,7	5	217211	217020
T27	49	6,2	5	217140* (217021)	217021
T30	49	6,2	5	217212	217022
T40	49	-	5	218020* (217023)	217023

* Solange vorrätig (Empfehlung für Ersatzartikel) / Available while stock lasts (proposal for substitute) / Disponible jusqu'à épuisement des stocks (proposition de remplacement)

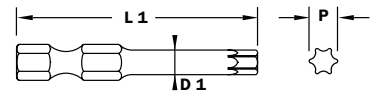

1/4" DIN 3126 E6.3



P	L1 mm	D1 mm		Classic XH
T8	70	4,0	5	221941
T9	70	4,0	5	221942** (221922)
T10	70	4,0	5	221943
T15	70	4,0	5	221944
T20	70	4,7	5	221945
T25	70	4,7	5	221946
T27	70	6,2	5	221947** (217021)
T30	70	6,2	5	221948
T40	70	-	5	221949



P	L1 mm	D1 mm		Classic XH
T8	89	4,0	5	221950
T9	89	4,0	5	221951** (221922)
T10	89	4,0	5	221952
T15	89	4,0	5	221953
T20	89	4,0	5	221954
T25	89	4,7	5	221955
T27	89	4,7	5	221956
T30	89	6,2	5	221957
T40	89	-	5	221958



P	L1 mm	D1 mm		Classic XH
T8	152	4,0	5	221968** (221950)
T10	152	4,0	5	221969
T15	152	4,0	5	221970
T20	152	4,0	5	221971
T25	152	4,7	5	221972
T27	152	4,7	5	221973
T30	152	6,2	5	221974
T40	152	-	5	221975** (221958)

** Nicht mehr lieferbar (Empfehlung für Ersatzartikel) / No longer available on stock (proposal for substitute) / Indisponible en stock (proposition de remplacement)

1/4" DIN 3126 C6.3

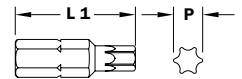

P	L1 mm		Classic XH
T10W	25	5	221980 [♦] (216984)
T15W	25	5	221981
T20W	25	5	221982
T25W	25	5	221983
T30W	25	5	221985

1/4" DIN 3126 E6.3

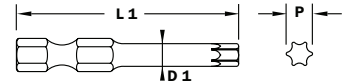



P	L1 mm		Classic XH
T10W	49	5	221990 ^{♦♦} (217017)
T15W	49	5	221991
T20W	49	5	221992
T25W	49	5	221993
T30W	49	5	221995

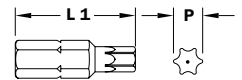

TORX® TAMPER RESISTANT

1/4" DIN 3126 C6.3



P	L1 mm		Classic XH
T7H	25	5	221996
T8H	25	5	221997
T9H	25	5	221998
T10H	25	5	221999
T15H	25	5	222000
T20H	25	5	222001
T25H	25	5	222002
T27H	25	5	222003
T30H	25	5	222004
T40H	25	5	222005

♦ Solange vorrätig (Empfehlung für Ersatzartikel) / Available while stock lasts (proposal for substitute) / Disponible jusqu'à épuisement des stocks (proposition de remplacement)

♦♦ Nicht mehr lieferbar (Empfehlung für Ersatzartikel) / No longer available on stock (proposal for substitute) / Indisponible en stock (proposition de remplacement)



1/4" DIN 3126 C6.3

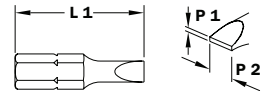

P	L1 mm	P1 mm	P2 mm		Iso-Temp [®]	MAXgrip ⁺	Magnator XH ⁺	Classic XH
0,5 x 3,0	25	0,5	3,0	10				222060
0,5 x 4,0	25	0,5	4,0	10	217226	221887	222006	217156
0,6 x 4,5	25	0,6	4,5	10	217227	222023	222007	217157
0,8 x 5,5	25	0,8	5,5	10	217220	222024	222008	217158
1,0 x 5,5	25	1,0	5,5	10	217221	221888		222009
1,0 x 6,0	25	1,0	6,0	10	216773 ^{♦♦} (222010)			222010
1,2 x 6,5	25	1,2	6,5	10	217222	221889	222011	217160
1,2 x 8,0	25	1,2	8,0	10	217228	222025	222012	217161
1,6 x 8,0	25	1,6	8,0	10	217229 [♦] (222013)	222026		222013
0-1	25	0,6	2,8	5				222027
1-2	25	0,7	3,2	5				222028
2-3	25	0,7	3,4	5				222029
3-4	25	0,8	3,9	5				222030
4-5	25	0,9	4,7	5				222031
5-6	25	0,9	5,4	5				222032
6-8	25	1	6,3	5				222033
8-10	25	1,1	7	5	265017			222034
10-12	25	1,2	7,1	5				222035
12-14	25	1,3	7,1	5				222036

5/16" DIN 3126 C8





P	L1 mm	P1 mm	P2 mm		Classic XH
16-18	25	1,5	12,6	5	265018

- ♦ Solange vorrätig (Empfehlung für Ersatzartikel) / Available while stock lasts (proposal for substitute) / Disponible jusqu'à épuisement des stocks (proposition de remplacement)
- ♦♦ Nicht mehr lieferbar (Empfehlung für Ersatzartikel) / No longer available on stock (proposal for substitute) / Indisponible en stock (proposition de remplacement)

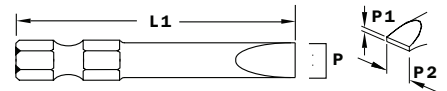

1/4" DIN 3126 E6.3



P	L1 mm	P1 mm	P2 mm		Classic XH
0,5 x 3,0	49	0,5	3,0	5	222037
0,5 x 4,0	49	0,5	4,0	5	222038
0,6 x 4,5	49	0,6	4,5	5	222039
0,8 x 5,5	49	0,8	5,5	5	222040
1,0 x 5,5	49	1,0	5,5	5	222041
1,0 x 6,0	49	1,0	6,0	5	222042
1,2 x 6,5	49	1,2	6,5	5	222043
1,2 x 8,0	49	1,2	8,0	5	222044
1,6 x 8,0	49	1,6	8,0	5	222045



P	L1 mm	P1 mm	P2 mm		Classic XH
0,5 x 3,0	70	0,5	3,0	5	222047
0,6 x 4,5	70	0,6	4,5	5	222049
0,8 x 5,5	70	0,8	5,5	5	222050
1,0 x 5,5	70	1,0	5,5	5	222051
1,2 x 6,5	70	1,2	6,5	5	222052



P	L1 mm	P1 mm	P2 mm		Classic XH
0,8 x 5,5	89	0,8	5,5	5	222056
1,0 x 5,5	89	1,0	5,5	5	222057
1,2 x 6,5	89	1,2	6,5	5	222058
1,2 x 8,0	89	1,2	8,0	5	222059



P	L1 mm	P1 mm	P2 mm		Classic XH
6 - 8	89 / 95	0,9	6,2	10	265013
6 - 10	89 / 95	1,0	7,1	10	265014



1/4" DIN 3126 C6.3

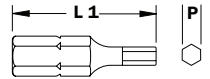

P	L1 mm		Classic XH
1,5 mm	25	5	222071
2 mm	25	5	222072
2,5 mm	25	5	222073
3 mm	25	10	222074
4 mm	25	10	222075
5 mm	25	10	222076
6 mm	25	10	222077
7 mm	25	5	222078
8 mm	25	5	222079
5/64"	25	5	222091
3/32"	25	5	222092
7/64"	25	5	222093
1/8"	25	5	222094
9/64"	25	5	222095
5/32"	25	5	222096
3/16"	25	5	222097
7/32"	25	5	222098
1/4"	25	5	222099
5/16"	25	5	222100

5/16" DIN 3126 C8

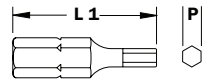

P	L1 mm		Classic XH
3 mm	32	5	222102
4 mm	32	5	222103
5 mm	32	5	222104
6 mm	32	5	222105
7 mm	32	5	222106
8 mm	32	5	222107
10 mm	32	5	222108

1/4" DIN 3126 E6.3

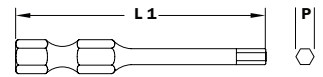

P	L1 mm		Classic XH
2 mm	49	5	222120
2,5 mm	49	5	222121
3 mm	49	5	222122
4 mm	49	5	222123
5 mm	49	5	222124
5/64"	49	5	265011

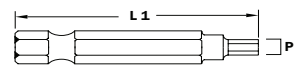

P	L1 mm		Classic XH
6 mm	49	5	222116



1/4" DIN 3126 C6.3

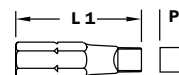

P	L1 mm		Iso-Temp®	Classic XH
R0	25	5	222140** (222135)	222135
R1	25	5	222141	222136
R2	25	5	222142	222137
R2	25	100		222138
R3	25	5	222143	222139

1/4" DIN 3126 E6.3

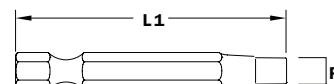

P	L1 mm		Iso-Temp®	Classic XH
R1	49	5	222148	222144
R2	49	5	222149	222145
R2	49	100		222146
R3	49	5	222150	222147



P	L1 mm		Classic XH
R1	70	5	222151
R2	70	5	222152
R3	70	5	222153



P	L1 mm		Classic XH
R1	89	5	222154
R2	89	5	222155



P	L1 mm		Classic XH
R2	102	5	222156* (222158)



P	L1 mm		Classic XH
R1	152	5	222157
R2	152	5	222158
R3	152	5	222159

* Solange vorrätig (Empfehlung für Ersatzartikel) / Available while stock lasts (proposal for substitute) / Disponible jusqu'à épuisement des stocks (proposition de remplacement)

** Nicht mehr lieferbar (Empfehlung für Ersatzartikel) / No longer available on stock (proposal for substitute) / Indisponible en stock (proposition de remplacement)

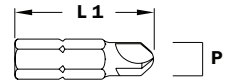
1/4" DIN 3126 C6.3

P	L1 mm		Iso-Temp®
0	25	5	222160
1	25	5	222161
2	25	5	222162
3	25	5	222163
4	25	5	222164
5	25	5	222165
6	25	5	222166
8	25	5	222167
10	25	5	222168

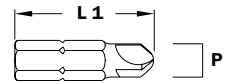
5/16" DIN 3126 C8

P	L1 mm		Iso-Temp®
1/4"	25	5	222171
5/16"	25	5	222172
3/8"	25	5	222173
10	25	5	224648*

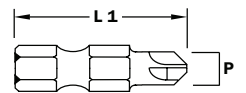
1/4" DIN 3126 E6.3

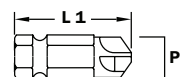

P	L1 mm		Iso-Temp®
0	32	5	222174
1	32	5	222175
2	32	5	222176
3	32	5	222177
4	32	5	222178
5	32	5	222179
6	32	5	222180
8	32	5	222181
10	32	5	222182

7/16" DIN 3126 E11.2

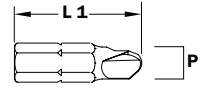

P	L1 mm		Iso-Temp®
1/4"	32	5	222402*
5/16"	32	5	222403
3/8"	32	5	224649*
7/16"	32	5	222405

* Solange vorrätig (Empfehlung für Ersatzartikel) / Available while stock lasts (proposal for substitute) / Disponible jusqu'à épuisement des stocks (proposition de remplacement)

1/4" DIN 3126 C6.3

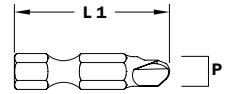
P	L1 mm		Iso-Temp®
0	25	5	222183
1	25	5	222184
2	25	5	222185
3	25	5	222186
4	25	5	222187
5	25	5	222188

1/4" DIN 3126 E6.3

P	L1 mm		Iso-Temp®
0	32	5	222190** (222183)
1	32	5	222191* (222184)
2	32	5	222192** (222185)
3	32	5	222193*
4	32	5	222194** (222187)
5	32	5	222195** (222188)

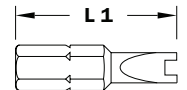

SPANNER
1/4" DIN 3126 C6.3

P	L1 mm		Iso-Temp®
SP6	25	5	224650
SP8	25	5	224651
SP10	25	5	224652

* Solange vorrätig (Empfehlung für Ersatzartikel) / Available while stock lasts (proposal for substitute) / Disponible jusqu'à épuisement des stocks (proposition de remplacement)

** Nicht mehr lieferbar (Empfehlung für Ersatzartikel) / No longer available on stock (proposal for substitute) / Indisponible en stock (proposition de remplacement)

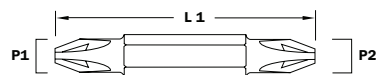
1/4"



P1	P2	L1 mm	
PZ2	PZ2	60	10

Classic XH
222217

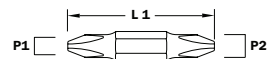

P1	P2	L1 mm	
PH2	PH2	60	10

Classic XH
222219

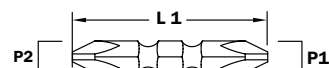

P1	P2	L1 mm	
PH2	PH2	45	10

Classic XH
222220

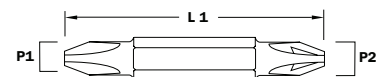

P1	P2	L1 mm	
PH2	PZ2	45	10

Classic XH
222221

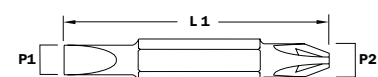

P1	P2	L1 mm	
0,6 x 4,5	PZ1	60	10
0,8 x 5,5	PZ2	60	10

Classic XH
222222
222223

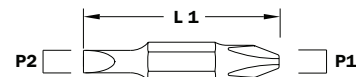

P1	P2	L1 mm	
1,0 x 5,5	PH2	45	10
0,8 x 5,5	PH2	60	10

Classic XH
222224
222225

**1/4" 7 TLG/PCS**

P	L1 mm		7	MAXgrip ⁺	Set: 221394
⊕ Ph1	25	C6.3		1 x	
⊕ Ph2	25	C6.3		1 x	
⊕ Pz1	25	C6.3		1 x	
⊕ Pz2	25	C6.3		1 x	
● LS0,8 x 5,5	25	C6.3		1 x	
● LS1,2 x 6,5	25	C6.3		1 x	
UH	54	E6.3		1 x	

1/4" 7 TLG/PCS

P	L1 mm		7	Magnator XH ⁺	Set: 221395
⊕ Ph1	25	C6.3		1 x	
⊕ Ph2	25	C6.3		1 x	
⊕ Ph3	25	C6.3		1 x	
⊕ Pz1	25	C6.3		1 x	
⊕ Pz2	25	C6.3		1 x	
⊕ Pz3	25	C6.3		1 x	
UH	54	E6.3		1 x	

1/4" 7 TLG/PCS

P	L1 mm		7	MAXgrip ⁺	Set: 221399
⊕ Ph1	25	C6.3		1 x	
⊕ Ph2	25	C6.3		1 x	
⊕ Ph3	25	C6.3		1 x	
⊕ Pz1	25	C6.3		1 x	
⊕ Pz2	25	C6.3		1 x	
⊕ Pz3	25	C6.3		1 x	
UH	54	E6.3		1 x	

1/4" 7 TLG/PCS

P	L1 mm		7	Classic XH	Set: 221400
⊕ T10H	25	C6.3		1 x	
⊕ T15H	25	C6.3		1 x	
⊕ T20H	25	C6.3		1 x	
⊕ T25H	25	C6.3		1 x	
⊕ T30H	25	C6.3		1 x	
⊕ T40H	25	C6.3		1 x	
UH	54	E6.3		1 x	

1/4" 7 TLG/PCS

P	L1 mm		7	MAXgrip ⁺	Set: 221401
⊕ T10	25	C6.3		1 x	
⊕ T15	25	C6.3		1 x	
⊕ T20	25	C6.3		1 x	
⊕ T25	25	C6.3		1 x	
⊕ T30	25	C6.3		1 x	
⊕ T40	25	C6.3		1 x	
UH	54	E6.3		1 x	



SET

1/4" 7 TLG/PCS

P	L1 mm		7	Classic XH	Set: 221402
○ SW2	25	C6.3		1 x	
○ SW2,5	25	C6.3		1 x	
○ SW3	25	C6.3		1 x	
○ SW4	25	C6.3		1 x	
○ SW5	25	C6.3		1 x	
○ SW6	25	C6.3		1 x	
UH	54	E6.3		1 x	

1/4" 7 TLG/PCS

P	L1 mm		7	MAXgrip+	Set: 221403
⊕ Pz1	25	C6.3		1 x	
⊕ Pz2	25	C6.3		4 x	
⊕ Pz3	25	C6.3		1 x	
UH	54	E6.3		1 x	

1/4" 7 TLG/PCS

P	L1 mm		7	Classic XH	Set: 221412
⊕ T10	25	C6.3		1 x	
⊕ T15	25	C6.3		1 x	
⊕ T20	25	C6.3		1 x	
⊕ T25	25	C6.3		1 x	
⊕ T30	25	C6.3		1 x	
⊕ T40	25	C6.3		1 x	
UH	54	E6.3		1 x	

1/4" 12 TLG/PCS

P	L1 mm		12	Magnator XH+	Set: 221413
⊕ Ph1	25	C6.3		1 x	
⊕ Ph2	25	C6.3		2 x	
⊕ Ph3	25	C6.3		1 x	
⊕ Pz1	25	C6.3		1 x	
⊕ Pz2	25	C6.3		2 x	
⊕ Pz3	25	C6.3		1 x	
● LS0.8 x 5.5	25	C6.3		1 x	
● LS1.0 x 5.5	25	C6.3		1 x	
● LS1.2 x 6.5	25	C6.3		1 x	
UH	54	E6.3		1 x	

1/4" 12 TLG/PCS

P	L1 mm		12	Magnator XH+	Classic XH	Set: 221414
⊕ Ph1	25	C6.3		1 x		
⊕ Ph2	25	C6.3		1 x		
⊕ Pz1	25	C6.3		1 x		
⊕ Pz2	25	C6.3		1 x		
⊕ T10	25	C6.3			1 x	
⊕ T15	25	C6.3			1 x	
⊕ T20	25	C6.3			1 x	
⊕ T25	25	C6.3			1 x	
⊕ T27	25	C6.3			1 x	
⊕ T30	25	C6.3			1 x	
⊕ T40	25	C6.3			1 x	
UH	54	E6.3		1 x		

**SET****1/4" 12 TLG/PCS**

P	L1 mm		 12	MAXgrip⁺	Set: 221423
⊕ Ph1	25	C6.3		1 x	
⊕ Ph2	25	C6.3		2 x	
⊕ Ph3	25	C6.3		1 x	
⊕ Pz1	25	C6.3		1 x	
⊕ Pz2	25	C6.3		2 x	
⊕ Pz3	25	C6.3		1 x	
● LS0,6 x 4,5	25	C6.3		1 x	
● LS0,8 x 5,5	25	C6.3		1 x	
● LS1,2 x 8,0	25	C6.3		1 x	
UH	54	E6.3		1 x	

1/4" 16 TLG/PCS

P	L1 mm		 16	Magnator XH⁺	Classic XH	Set: 221424
⊕ Ph1	25	C6.3		1 x		
⊕ Ph2	25	C6.3		1 x		
⊕ Ph3	25	C6.3		1 x		
⊕ Pz1	25	C6.3		1 x		
⊕ Pz2	25	C6.3		1 x		
⊕ Pz3	25	C6.3		1 x		
⊕ T10	25	C6.3			1 x	
⊕ T15	25	C6.3			1 x	
⊕ T20	25	C6.3			1 x	
⊕ T25	25	C6.3			1 x	
⊕ T30	25	C6.3			1 x	
⊕ T40	25	C6.3			1 x	
● LS0,6 x 4,5	25	C6.3		1 x		
● LS0,8 x 5,5	25	C6.3		1 x		
● LS1,2 x 6,5	25	C6.3		1 x		
UH	54	E6.3			1 x	

1/4" 16 TLG/PCS

P	L1 mm		 16	MAXgrip⁺	Set: 221425
⊕ Ph1	25	C6.3		1 x	
⊕ Ph2	25	C6.3		1 x	
⊕ Ph3	25	C6.3		1 x	
⊕ Pz1	25	C6.3		1 x	
⊕ Pz2	25	C6.3		1 x	
⊕ Pz3	25	C6.3		1 x	
⊕ T10	25	C6.3		1 x	
⊕ T15	25	C6.3		1 x	
⊕ T20	25	C6.3		1 x	
⊕ T25	25	C6.3		1 x	
⊕ T30	25	C6.3		1 x	
⊕ T40	25	C6.3		1 x	
● LS0,6 x 4,5	25	C6.3		1 x	
● LS0,8 x 5,5	25	C6.3		1 x	
● LS1,2 x 8,0	25	C6.3		1 x	
UH	54	E6.3		1 x	



SET

1/4" 31 TLG/PCS



P	L1 mm	 31	Magnator XH⁺	Classic XH	Set: 221426
⊕ Ph1	25	C6.3	3 x		
⊕ Ph2	25	C6.3	3 x		
⊕ Ph3	25	C6.3	3 x		
⊕ Pz1	25	C6.3	3 x		
⊕ Pz2	25	C6.3	3 x		
⊕ Pz3	25	C6.3	3 x		
⊕ T10	25	C6.3		1 x	
⊕ T15	25	C6.3		1 x	
⊕ T20	25	C6.3		1 x	
⊕ T25	25	C6.3		1 x	
⊕ T30	25	C6.3		1 x	
⊕ T40	25	C6.3		1 x	
● LS0,6 x 4,5	25	C6.3	1 x		
● LS0,8 x 5,5	25	C6.3	1 x		
● LS1,2 x 6,5	25	C6.3	1 x		
○ SW4	25	C6.3		1 x	
○ SW5	25	C6.3		1 x	
○ SW6	25	C6.3		1 x	
UH	54	E6.3		1 x	



1/4" 31 TLG/PCS

P	L1 mm	 31	MAXgrip⁺		Set: 221427
⊕ Ph1	25	C6.3	3 x		
⊕ Ph2	25	C6.3	3 x		
⊕ Ph3	25	C6.3	3 x		
⊕ Pz1	25	C6.3	3 x		
⊕ Pz2	25	C6.3	3 x		
⊕ Pz3	25	C6.3	3 x		
⊕ T10	25	C6.3	1 x		
⊕ T15	25	C6.3	1 x		
⊕ T20	25	C6.3	2 x		
⊕ T25	25	C6.3	2 x		
⊕ T30	25	C6.3	2 x		
⊕ T40	25	C6.3	1 x		
● LS0,6 x 4,5	25	C6.3	1 x		
● LS0,8 x 5,5	25	C6.3	1 x		
● LS1,2 x 8,0	25	C6.3	1 x		
UH	54	E6.3	1 x		

SCHNELLWECHSEL-BITHALTER QUICK-CHANGE BIT HOLDERS PORTE-EMBOUS AVEC FIXATION RAPIDE



1/4" DIN 3126 E6.3 2-teilig / 2 pieces / 2 pièces

B	L mm	D mm		
1/4"	59	14	*	232256
1/4"	75	14	*	265025

SDS Plus 2-teilig / 2 pieces / 2 pièces

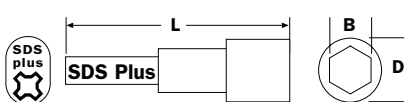



B	L mm	D mm		
1/4"	79	14	*	232255

BITHALTER / BITHOLDER / PORTE-EMBOUS

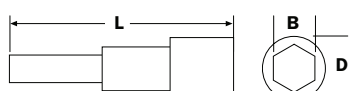

1/4" DIN 3126 C6.3 2-teilig / 2 pieces / 2 pièces

B	L mm	D mm		
1/4"	44	9,4	*	232236



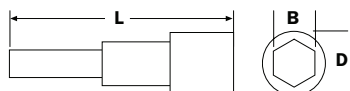

1/4" DIN 3126 E6.3 2-teilig / 2 pieces / 2 pièces

B	L mm	D mm			
1/4"	54	9,4	*		232227
1/4"	54	9,5	*	•	232237
1/4"	73	9,4	*	•	232234
1/4"	75	11,1	*	•	232253
1/4"	102	9,4	*	•	232242
1/4"	127	9,4	*	•	232244
1/4"	152	9,4	*	•	232245
1/4"	279	9,4	*	•	232246

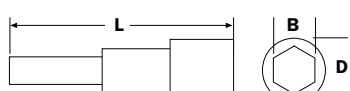
1/4" DIN 3126 E6.3 1-teilig / 1 piece / 1 pièce







B	L mm	D mm				
1/4"	56	9,6	*		232254	
1/4"	73	9,4	*		232251	
1/4"	54	11,1	*	•		232235
1/4"	73	9,4	*	•	232240	
1/4"	75	11,1	*	•	232252	

* Bestellmenge kann frei gewählt werden. / Order quantity can be freely selected. / La quantité de commande peut être sélectionnée librement.

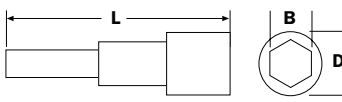
BITHALTER / BIT HOLDER / PORTE-EMBOUTS



1/4" DIN 3126 E6.3 **m. Schraubkappe. 1-teilig / w. screw cap. 1 piece / avec fixation à visser. 1 pièce**

B	L mm	D mm			
1/4"	59	9,4	*	•	232239
1/4"	127	9,4	*	•	232241
1/4"	152	9,4	*	•	232243

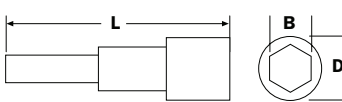

1/4" DIN 3126 E6.3 **m. Schraubkappe. 1-teilig / w. screw cap. 1 piece / avec fixation à visser. 1 pièce**

B	L mm	D mm			
1/4"	73	9,4	*	•	232238

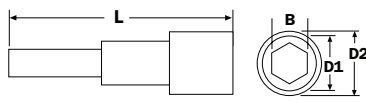

1/4" DIN 3126 E6.3 **SILICON BRONZE◇ 2-teilig / 2 pieces / 2 pièces**

B	L mm	D1 mm	D2 mm			
1/4"	76	9,4	11,1	*	•	232249

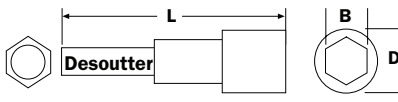

5/16" DIN 3126 E6.3 **DESOUTTER 2-teilig / 2 pieces / 2 pièces**

B	L mm	D mm			
5/16"	73	9,5	*	•	232250

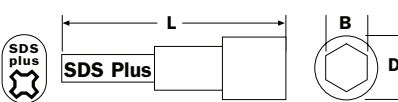

SDS Plus 2-teilig / 2 pieces / 2 pièces

B	L mm	D mm			
1/4"	98	11,1	*	•	232247

G7 DIN 3126 G7 **2-teilig / 2 pieces / 2 pièces**

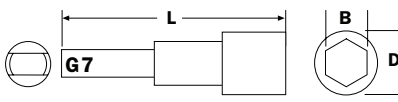





B	L mm	D mm			
G7	75	9,6	*	•	232248

* Bestellmenge kann frei gewählt werden. / Order quantity can be freely selected. / La quantité de commande peut être sélectionnée librement.
 ◇ Verhindert Funkenschlag. / Prevents sparks. / Evite la formation d'étincelles.

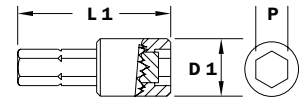
STECKSCHLÜSSELEINSÄTZE / NUTSETTERS / DOUILLES DIRECTES

1/4" DIN 3126 C6.3



P	L1 mm	D1 mm		
7 mm	28	11	*	232218
8 mm	28	13	*	232219
10 mm	32	14	*	232220
1/4"	28	11	*	232214
5/16"	28	13	*	232215** (232168)
3/8"	32	14	*	232216** (232179)

1/4" DIN 3126 E6.3

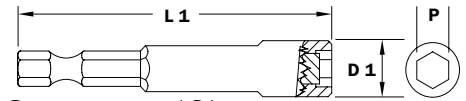



P	L1 mm	D1 mm			
6 mm	41	11	*	232208	
7 mm	41	13	*	232217	232176
8 mm	41	13	*	232209	232177
10 mm	48	14	*	232210	232178** (232226)
5,5 mm	65	11	*	232158	
6 mm	65	11	*	232159	
7 mm	65	13	*	232160	232224* (232176)
8 mm	65	13	*	232161	232225
10 mm	65	14	*	232162	232226
12 mm	65	14	*	232228	232230
13 mm	65	14	*	232229	232231
1/4"	41	11	*	232167	
5/16"	41	13	*	232168	
3/8"	48	14	*	232179	
1/4"	65	11	*	232155	
5/16"	65	12,8	*	232156	
3/8"	65	14	*	232157	
7/16"	65	16	*	232213*	

1/4" DIN 3126 E6.3

mit Feder / with spring / avec ressort



P	L1 mm	D1"		
8 mm	65	9/16	*	232232
3/8"	65	9/16	*	232233

- * Solange vorrätig (Empfehlung für Ersatzartikel) / Available while stock lasts (proposal for substitute) / Disponible jusqu'à épuisement des stocks (proposition de remplacement)
- ** Nicht mehr lieferbar (Empfehlung für Ersatzartikel) / No longer available on stock (proposal for substitute) / Indisponible en stock (proposition de remplacement)
- * Bestellmenge kann frei gewählt werden. / Order quantity can be freely selected. / La quantité de commande peut être sélectionnée librement.

STECKSCHLÜSSEL / SOCKETS / DOUILLES

1/4"

Konisch / tapered / conique

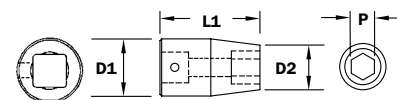

P	L1 mm	D1 mm	D2 mm		
5,5 mm	22	13	9	*	232183 [♦]
1/4"	22	13	10	*	232163 [♦]

1/4"

Zylindrisch / straight / cylindrique

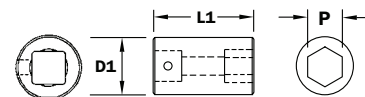

P	L1 mm	D1 mm			
7 mm	22	13	*	232185	232197
8 mm	22	13	*	232186	232198
10 mm	25	17,5	*	232188	232200
13 mm	25	19	*	232191 ^{♦♦} (232203)	232203
1/4"	22	13	*		232211 [♦]
5/16"	22	13	*	232166	232165

VERLÄNGERUNGEN / EXTENSIONS / RALLONGES

1/4"

DIN 3126 C6.3

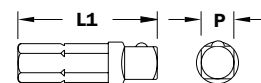

P	L1 mm			
1/4"	25	*	232204	232221

1/4"

DIN 3126 E6.3

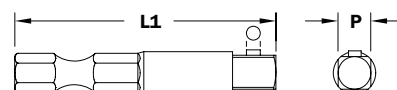

P	L1 mm			
1/4"	51	*	232174	232223
1/4"	76	*	232205	
1/4"	102	*	232169	
1/4"	152	*	232170	
1/4"	203	*	232206	
3/8"	51	*	232175	
3/8"	76	*	232207	

♦ Solange vorrätig (Empfehlung für Ersatzartikel) / Available while stock lasts (proposal for substitute) / Disponible jusqu'à épuisement des stocks (proposition de remplacement)

♦♦ Nicht mehr lieferbar (Empfehlung für Ersatzartikel) / No longer available on stock (proposal for substitute) / Indisponible en stock (proposition de remplacement)

* Bestellmenge kann frei gewählt werden. / Order quantity can be freely selected. / La quantité de commande peut être sélectionnée librement.

ADAPTER VIERKANT-HEX / ADAPTER SQUARE-HEX / ADAPTATEUR HEX. À TÊTE CARRÉE

1/4" Vierkant / square / carrée



P **L1 mm**
1/4" **29**

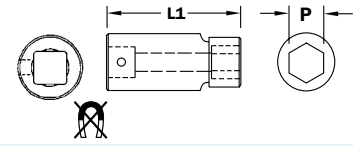

232171

3/8" Vierkant / square / carrée



P **L1 mm**
1/4" **29**
5/16" **35**

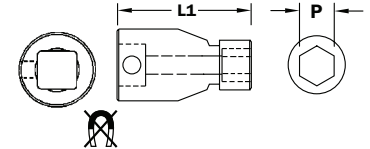

232172

232173

SCHRAUBENZIEHER / SCREWDRIVER / TOURNEVIS

1/4"



P **L1 mm**
1/4" **67**
1/4" **187**
1/4" **190**
1/4" **279**

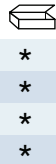

265022
265021
265024
265023

* Bestellmenge kann frei gewählt werden. / Order quantity can be freely selected. / La quantité de commande peut être sélectionnée librement.

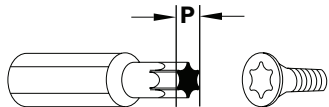

P

T1	0,84 mm
T2	0,94 mm
T3	1,12 mm
T4	1,30 mm
T5	1,37 mm
T6	1,65 mm
T7	1,97 mm
T8	2,30 mm
T9	2,48 mm
T10	2,72 mm
T15	3,26 mm
T20	3,84 mm
T25	4,40 mm
T27	4,96 mm
T30	5,49 mm
T40	6,60 mm
T45	7,77 mm
T50	8,79 mm
T55	11,17 mm
T60	13,20 mm
T70	15,49 mm

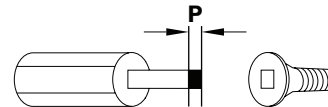

P

R00	1,27 mm
R0	1,78 mm
R1	2,31 mm
R2	2,85 mm
R3	3,37 mm
R4	4,84 mm

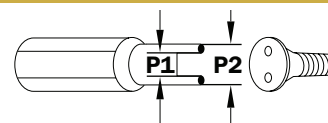

P1

P2

SP6	2,5 mm	4,3 mm
SP8	2,8 mm	5,3 mm
SP10	3,6 mm	6,2 mm